



**HS6001**  
**Multipurpose Shear with Non-Slip Grip & Serrated Jaws 145 mm**







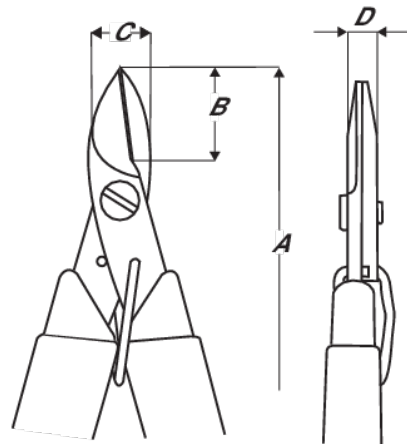

**PRODUCT DETAILS**

- User-friendly, durable and fits comfortably in either hand
- High carbon steel blades with a hardness of 57–59 HRC
- Serrations on one cutting edge to prevent the material being cut from sliding away (HS6000)
- Precision screw joint that minimizes friction and maximizes alignment of cutting edges
- ESD safe non-slip, foam cushioned grips
- Ideal for cutting insulation, cables, cable ties, and corded material of all types



PRODUCT ATTRIBUTES

Product: **HS6001**

	Smooth-Jaws		L		Flush
	Kevlar	<b>A</b>	145 mm	<b>A</b>	5.7 in
<b>B</b>	29 mm	<b>B</b>	1.1 in	<b>C</b>	12.7 mm
<b>C</b>	0.5 in	<b>D</b>	6.4 mm	<b>D</b>	0.2 inch
	Smooth		88 g	<b>Ω</b>	Dissipative