

GRS[®] Magnum[®] & Magnum[®] Airtact Handpiece

INSTRUCTIONS • #004-940, #004-940-OVAL, #004-941, #004-940-ATSS & #004-957SS

	Standard Spring
Normal Operating Range	18-22 psi (1.2-1.5 bar) / 1400 - 3400 spm
Recommended Initial Setting	19 psi (1.3 bar) / 2700 spm
PSI: Pounds per Square Inch • Bar: Unit of Measurement • SPM: Strokes Per Minute	

ADJUSTING THE HANDPIECE

To position the hose, loosen the locking ring a little. With the locking ring slightly loose, the handpiece body and knob can be turned independently. Position the Quick Change holder with the graver "point" down. Rotate the knob until the hose position is comfortable, then tighten the locking ring.

The length of the handpiece can be extended a little by unscrewing the knob and body even more. NOTE: When the handpiece length is extended, a loss of power may occur, depending on the type of work being done.

ATTACHING A NEW HOSE

Loosen the locking ring (**Fig. 1**). Remove the knob from the handpiece. Remove the hose by cutting it off close to the knob. With a small punch, push the hose / brass fitting back into the knob body. Remove the brass fitting (#044-031) from the hose. Feed the new air hose through the hole in the knob (**Fig. 2**). Insert the brass fitting into the end of the new hose, making sure it is fully seated.

If needed, lubricate the fitting first to help it slip into the hose easier. Then apply a small amount of water or oil around the outside end of the hose next to the brass fitting and pull the hose back (**Fig. 3**) into the knob until you see the tip of the brass fitting protrude through the side of the knob. This must be an air tight fit, so a bit of force may be needed (a few pounds of pressure, at least).

MAINTENANCE

Keep the Magnum handpiece clean on the inside. Problems will occur if oil or moisture gets into the handpiece, especially on the piston. If you notice a loss of power or erratic performance, first check if the receiver (chuck) is tight in the handpiece body. Using a crescent wrench or pliers with a graver inserted in the QC Holder, gently tighten receiver clockwise (**Fig. 4**) If erratic performance continues, then disassemble and clean the handpiece. To disassemble the handpiece, use the crescent wrench or pliers to grip the graver (**Fig. 4**) and turn it counterclockwise to loosen the chuck retainer.

After loosening, turn the chuck retainer out with your finger tips (**Fig. 5**). As the chuck is pulled out, there will be a spring and piston that follows. Loosen the locking ring and remove it (**Fig. 6**). Grip the knob and turn the handpiece body counterclockwise until it is out of the knob body (**Fig. 7**).

Now, with the handpiece disassembled, clean the parts with a non-residue solvent like denatured alcohol. Make sure the holes in the handpiece body are clear from dirt and debris. DO NOT get moisture down the air hose. If this happens you will need to clear and dry it before reassembly.

Before reassembly, make sure every thing is completely dry. DO NOT OIL INSIDE THE HANDPIECE. NO lubricant is required. Lubricant will actually decrease performance!

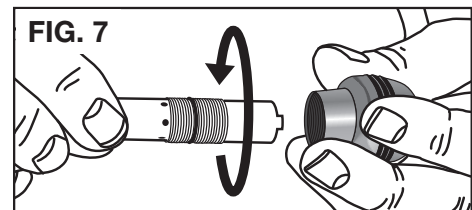
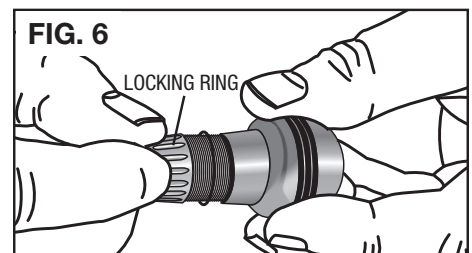
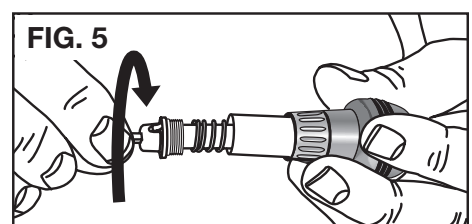
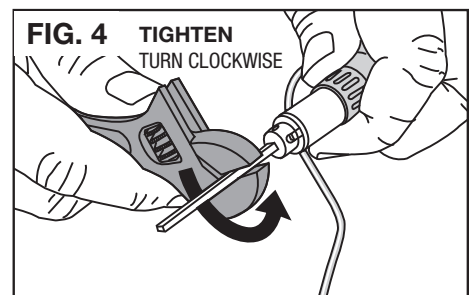
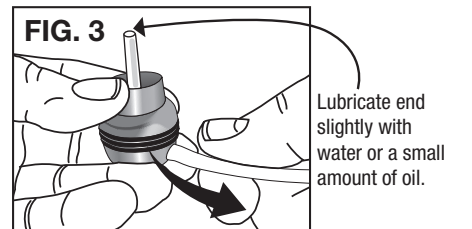
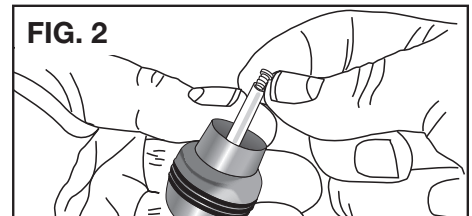
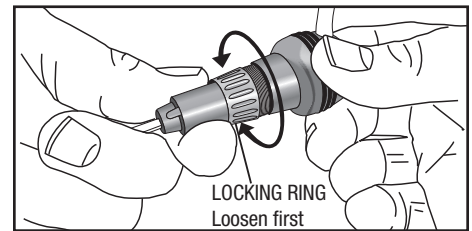

REASSEMBLY NOTE

There is an O-ring inside the knob that makes getting the handpiece body to thread a little difficult when reassembling. Use a very small amount of synthetic lube or non-stick grease and create a thin film around the OUTSIDE of the handpiece body between the threads and the end (Fig. 8). See "Adjusting The Handpiece" on p. 1 of this literature sheet for adjusting graver and hose position.



NOTE: Do NOT use petroleum based oils - USE ONLY Synthetic oils. Fossil oils can damage the O-Rings.

QUICK CHANGE HOLDER HINT

Synthetic Lube or non-stick grease on the shaft of a quick change holder will make them easier to slip in and out.

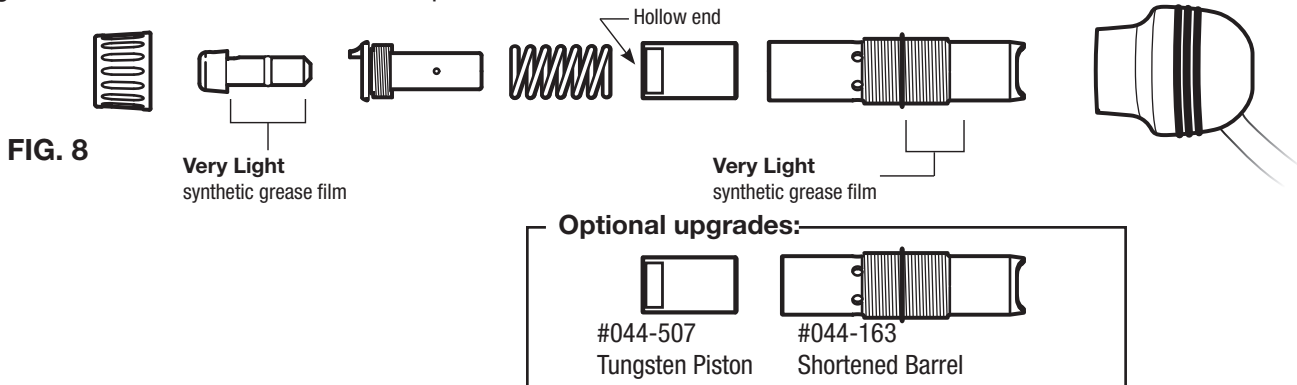

Magnum® Handpiece

PARTS LIST • #004-940

PART #	DESCRIPTION	QTY.
004-989	RECEIVER ASSEMBLY	1
044-025	HANDPIECE BARREL (MAGNUM)	1
044-026	LOCK NUT (MAGNUM)	1
002-127	O-RING, .754"OD .614"ID	2
044-030	PALM KNOB (MAGNUM)	1
044-031	HOSE RETAINER	1
044-028	TUBING, 050-003, 40"L	1
022-072	PLASTIC 1/4 TUBE CONNECTOR	1
044-029	TUBING, 050-002, 4"L	1
022-948	O-RING, 1.078"OD .938"ID	3
004-803	QC HOLDER	6
002-605	WRENCH, 5/64 ALLEN	1
044-023	SPRING COMPRESSION	1
044-507	HEAVY PISTON, MAGNUM	1

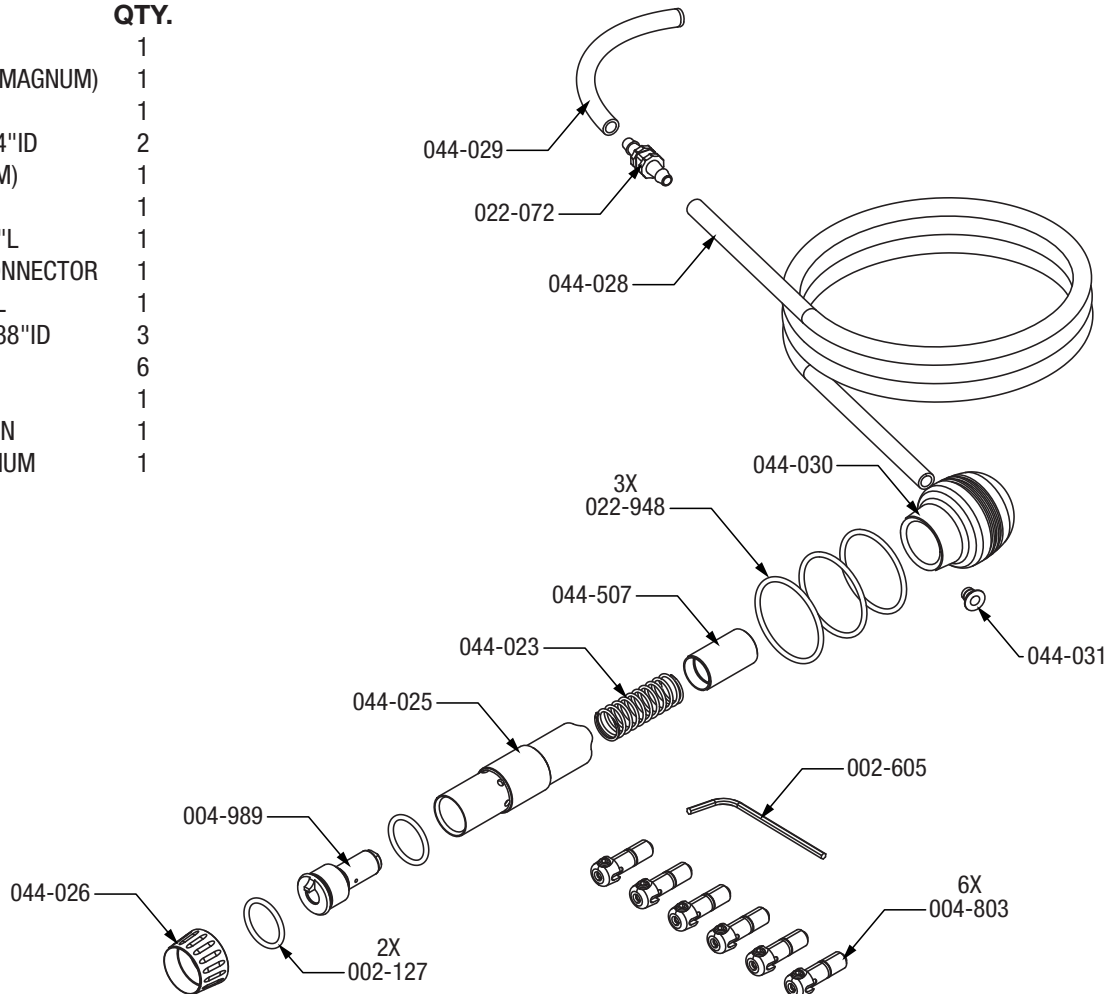

Oval Magnum® Handpiece

PARTS LIST • #004-940-OVAL

PART #	DESCRIPTION	QTY.
044-025	HANDPIECE BARREL (MAGNUM)	1
044-026	LOCK NUT (MAGNUM)	1
002-127	O-RING, .754"OD .614"ID	2
004-803	QC HOLDER	6
002-605	WRENCH, 5/64 ALLEN	1
044-027	OVAL KNOB (MAGNUM)	1
004-281	HOSE RETAINER	1
022-948	O-RING, 1.078"OD .938"ID	3
044-028	TUBING, 050-003, 40" L	1
022-072	PLASTIC 1/4 TUBE CONNECTOR	1
044-029	TUBING, 050-002, 4" L	1
044-023	SPRING COMPRESSION	1
044-507	HEAVY PISTON, MAGNUM	1
004-989	RECEIVER ASSEMBLY	1

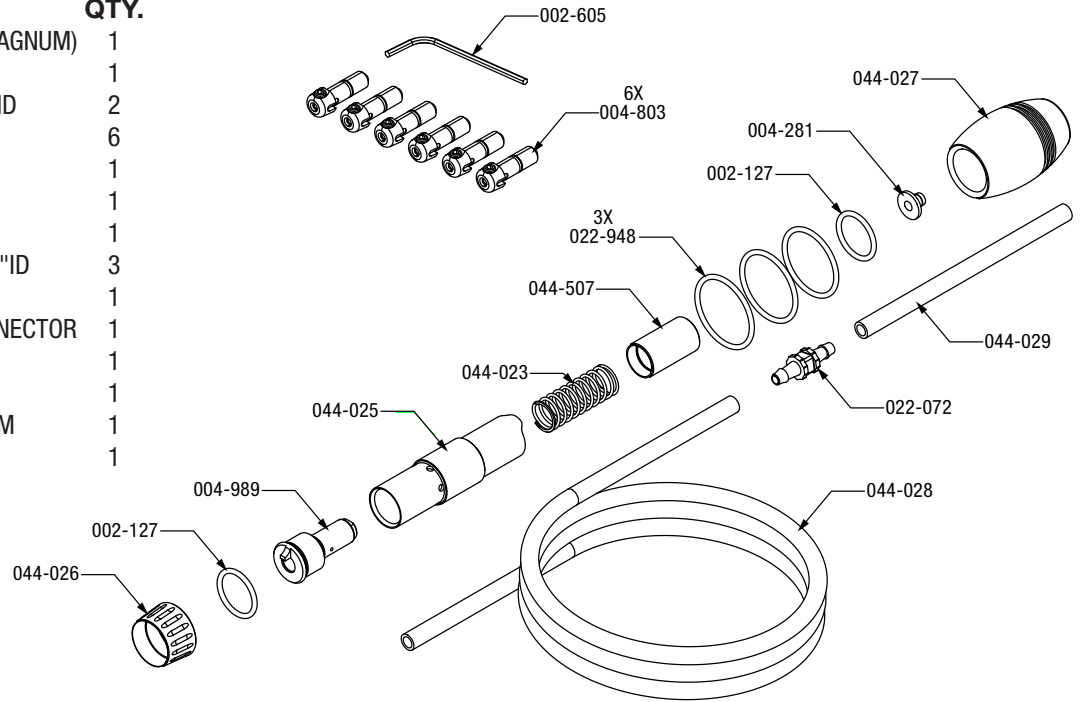

Magnum® Airtact Handpiece

PARTS LISTS • #004-940-ATSS

PART #	DESCRIPTION	QTY.
002-127	O-RING, .754"OD .614"ID	2
002-605	WRENCH, 5/64 ALLEN	1
004-803	QC HOLDER	6
022-072	PLASTIC 1/4 TUBE CONNECTOR	1
023-024	PHILLIPS RD HEAD MACHINE SCREW	8
023-029	FITTING, M-.063"ID TUBE F-LUER	1
044-023	SPRING COMPRESSION	1
044-025	HANDPIECE BARREL (MAGNUM)	1
044-026	LOCK NUT (MAGNUM)	1
044-028	TUBING, 050-003, 40" L	1
044-029	TUBING, 050-002, 4" L	1
044-031	HOSE RETAINER	1
044-126	FITTING, .094"OD .063"ID X .35"	1
044-130	TUBING, 050-054, 43.6" L	1
044-162SS	PALM KNOB (MAGNUM)	1
044-219	INLET INSERT FOR MAGNUM AT KNOBS	1
044-231	BRAIDED SLEEVE, 050-066, 36" L	1
044-507	HEAVY PISTON, MAGNUM	1
044-303	HEAT SHRINK WRAP, 050-091, 1" L	2
004-944	ACTUATOR PALM CAP AND COVER KIT FOR AT HANDPIECES	1
024-201	PH1 x 50 MM screw driver	1
004-989	RECEIVER ASSEMBLY	1

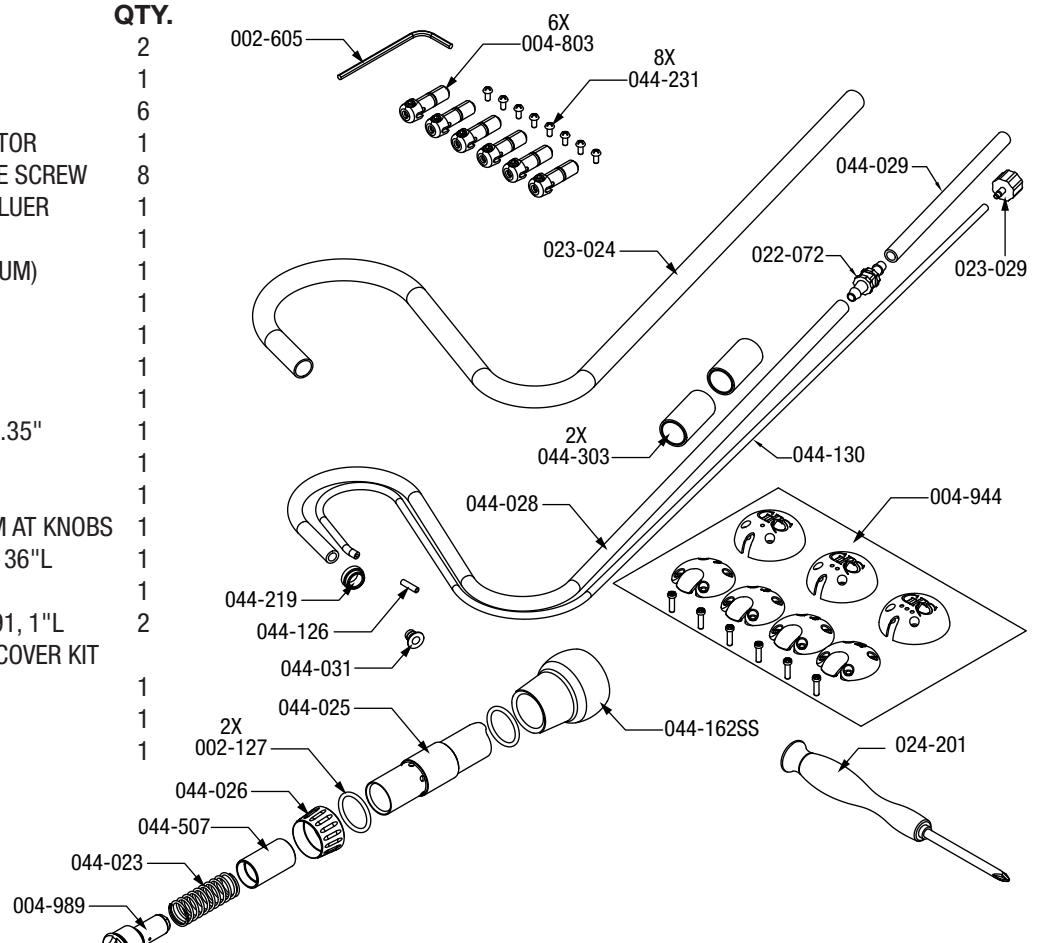

Magnum® Airtact Palm Knob Kit

PARTS LIST • #004-957-SS

PART #	DESCRIPTION	QTY.
002-127	O-RING, 0.750" O.D. 0.610" I.D.	1
022-072	TUBE COUPLING, 0.170" I.D.	1
023-024	SHCS, #2-56 x 0.19" S/S	8
024-201	SCREWDRIVER, PH #1 X 50 MM LG	1
023-029	FITTING, M-0.063" I.D. TUBE F-LUER	1
044-028	TUBING, PU CLR 0.250" O.D. 0.160" I.D.	1
044-029	TUBING, PU CLR 0.250" O.D. 0.170" I.D.	1
044-031	HOSE RETAINER	1
044-126	FITTING, 0.094" O.D. 0.063" I.D. x 0.35"	1
044-130	TUBING, PU CLR 0.125" O.D. 0.063" I.D.	1
044-162SS	PALM KNOB (MAGNUM)	1
044-303	12 MM DIA BLACK SHRINK TUBING	2
044-219	INLET INSERT FOR MAGNUM AT KNOBS	1
044-231	BRAIDED SLEEVE, 0.375" O.D. NYLON	1
004-944	HANDPIECE ACTUATOR ASSEMBLY	1

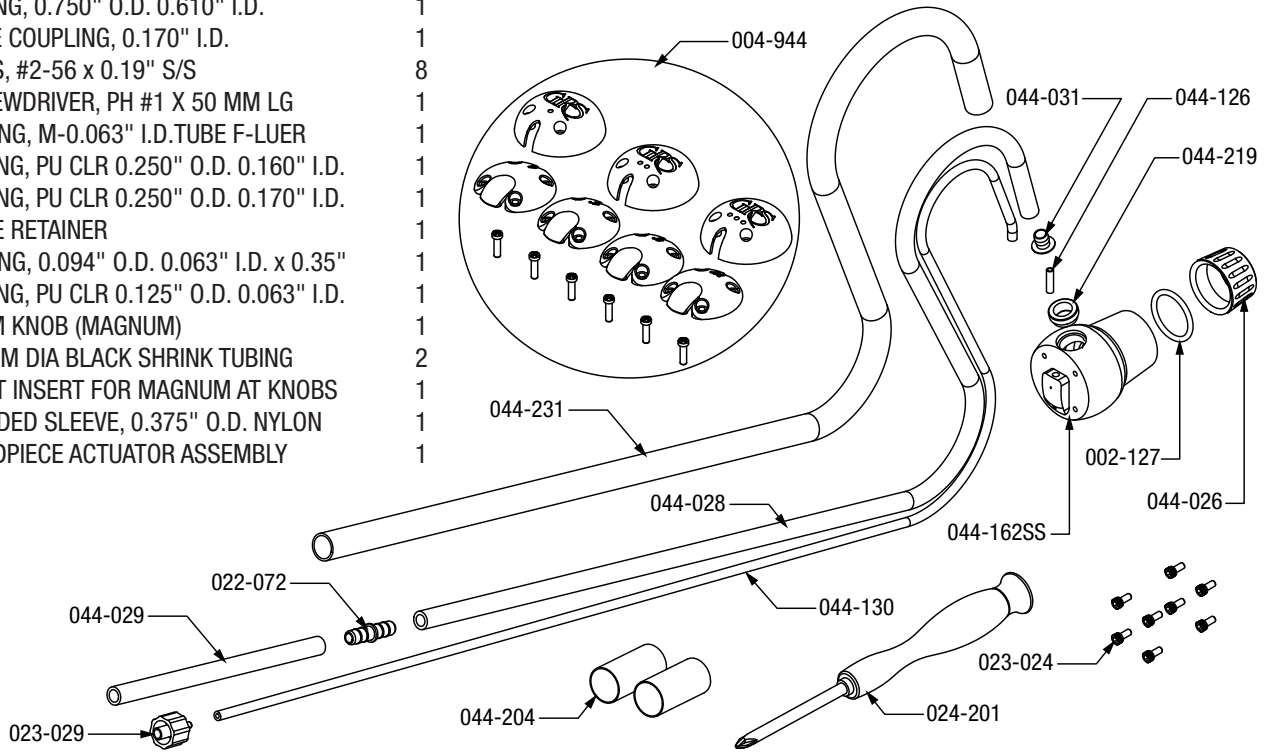

Palm Pad

FINE ADJUSTMENT • #004-940-ATSS & #004957SS

TYPE-E PALM PADS

The latest palm pad design for Airtact® hand control is Type-E, available in four sensitivity levels: 4, 6, 8, and 10. The handpiece is more responsive (less force required to activate) with a lower number palm pad installed.

Initially, palm pads can be stiff. This affects the feel and control. Stiffness may be reduced naturally with a few hours of use. To reduce stiffness quickly, bend and twist the control flap to soften. When the preferred softness is nearly reached, stop and test frequently to adjust until desired responsiveness is attained. The rubber control flap can be formed for a custom feel as well.

FORMING THE RUBBER CONTROL FLAP

The flexible rubber control flap on the Palm Pad transforms hand force into handpiece power by progressively covering a small air vent hole in the upper rear of the Airtact® handpiece knob.

Forming or bending the control flap one way (**concave**) increases the required hand force; bending it the other way (**convex**) decreases hand force.

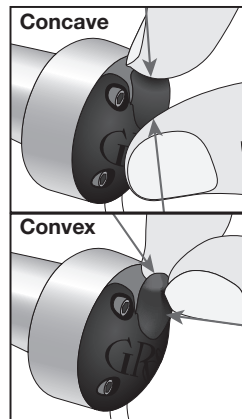

To increase required hand force:
Bend the control flap into a more concave shape. Bending the flap this direction keeps the flap from sealing off the Airtact® knob hole until more hand force is applied.

To decrease required hand force:
Bend the flap into a more convex shape to decrease the hand force required. This shape seals the Airtact® Knob hole with less force applied.

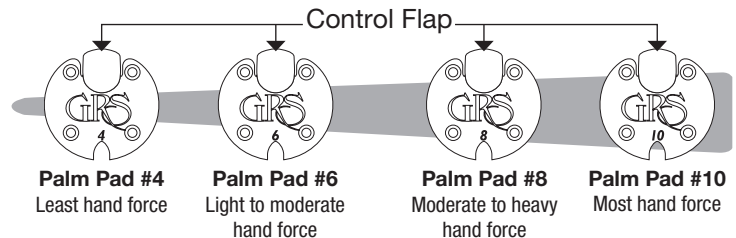

Please Note: the Palm Pad mounting screws should only be lightly snug; over-tightening can distort or damage the pad.

GLENDO LLC

900 Overlander Road • Emporia, KS 66801 USA
800-835-3519 • 620-343-1084 • Fax: 620-343-9640
hello@grs.com • www.grs.com
Last Updated: 12/10/21