

## ORIGINAL INSTRUCTIONS



# GRAVERMAX®

#005-985

OPERATION MANUAL

**READ THIS MANUAL ENTIRELY  
BEFORE CONNECTING TO POWER.**

Damage not covered by the warranty may result from not following the instructions and maintenance in this manual.

## NOTICE

 This engraving system requires clean, dry, oil-free air. An oil-free compressor is recommended for use with this system. For any oil-type compressors, an oil-removal filter (coalescing type) in the air supply line to this engraving system **MUST BE INSTALLED AND IN USE.**

**OIL OR WATER CONTAMINATION  
IS NOT COVERED BY WARRANTY.**

For help with ordering or installing an oil-removal filter, or for guidance with operation or maintenance, please contact GRS® or an authorized GRS® dealer. To send a request for assistance via electronic formats, e-mail [support@glendo.com](mailto:support@glendo.com) or visit:

[grs.com/contact-us/](http://grs.com/contact-us/)

Important notes are **highlighted in yellow** or **marked in red.**

# MANUAL CONTENTS

---

|   |           |
|---|-----------|
| <b>Important Notice For Operators</b> . . . . .           | <b>1</b>  |
| <b>Required Equipment &amp; Important Notes</b> . . . . . | <b>2</b>  |
| <b>GraverMax Overview</b> . . . . .                       | <b>4</b>  |
| <b>Introduction, Operation Note</b> . . . . .             | <b>5</b>  |
| <b>Setup &amp; Connections</b> . . . . .                  | <b>6</b>  |
| <b>Power &amp; Settings</b> . . . . .                     | <b>10</b> |
| <b>Handpiece Tuning</b> . . . . .                         | <b>10</b> |
| <b>Operation &amp; Troubleshooting</b> . . . . .          | <b>13</b> |
| <b>Important Notices</b> . . . . .                        | <b>14</b> |
| <b>Service &amp; Repair</b> . . . . .                     | <b>14</b> |
| <b>Specifications</b> . . . . .                           | <b>15</b> |
| <b>Warranty</b> . . . . .                                 | <b>18</b> |

**READ THIS MANUAL ENTIRELY  
BEFORE CONNECTING TO POWER.**

---

Damage not covered by the warranty may result from not following the instructions and maintenance in this manual.

# IMPORTANT NOTICE FOR OPERATORS

---

Read this manual thoroughly before operation. Training is not required but is recommended before use of this product. The manufacturer is not responsible for injury resulting from improper operation or when used by untrained operators.

 **Do not modify this equipment or remove warning labels. Modifications can increase risks to the operator. Do not use this equipment if it is damaged.** This equipment allows the use of small sharp cutting tools that can break suddenly. Always wear eye protection appropriate for each application, and protect hands from sharp edges.

Like other power tools, this device exposes the operator to mechanical vibration. If any user experiences discomfort, pain, numbness, aching, etc., in their hands, fingers, arms, or related joints, discontinue use and consult with an appropriate health professional.

Although this equipment does not generate dust itself, the tools used in the handpieces may do so. When sharpening tools, the user should take appropriate steps to avoid dust inhalation. Certain tool materials generate harmful dust while being ground or sharpened.



## FOR PROPER OPERATION, THIS SYSTEM REQUIRES:

- Included 24-volt power converter connected to a properly grounded electrical power outlet
- 
- Clean, dry, oil-free air provided by an air compressor
- 
- A compatible GRS® pneumatic handpiece
- 
- A graver or similar tool
- 
- A clean, sturdy work surface with adequate lighting
- 
- Workholding device or material
-

# READ THIS MANUAL ENTIRELY BEFORE CONNECTING TO POWER.

Damage not covered by the warranty may result from not following the instructions and maintenance in this manual.



## REQUIRED EQUIPMENT & IMPORTANT NOTES

---

- **Included 24-volt power converter**



**USE ONLY THE SUPPLIED 24-VOLT POWER CONVERTER. VISUALLY INSPECT POWER CORD FOR DAMAGE BEFORE CONNECTING TO AC POWER.** The included power converter may be connected to any properly grounded single-phase source of AC power within a voltage range of 100 to 220 V, 50 or 60 Hz. If necessary, use a suitable adapter. The power converter must be used with a suitable grounded electrical system. Using it with an ungrounded system could expose the equipment to electrical damage. Do not use older generation power converters. If a replacement is needed, contact GRS® or an authorized GRS® dealer to order #022-987.



**DO NOT OPERATE THE MACHINE WITHOUT A COMPRESSED AIR SUPPLY.** Compressed air not only provides the handpiece with power, it lubricates internal components including the rotary air valve. Do not add oil or any lubricant to the compressed air supply.

---

- **A compatible GRS® pneumatic handpiece**

All GRS® Standard Handpieces are compatible with this system. **DO NOT USE SYSTEM 3 OR GraverMeister® HANDPIECES.** Please contact GRS® or an authorized GRS® dealer for a complete list of compatible handpieces.

---

- **A graver or similar tool**



A properly sharpened graver or similar tool is required to cut through the surface of metal and other materials; use with care. **The dust created while sharpening some tool materials may present a health risk.** Please contact GRS® or an authorized GRS® dealer for a list of available gravers and tools.

---

# REQUIRED EQUIPMENT & IMPORTANT NOTES

(CONTINUED)

---

- **Clean, dry, oil-free air from an air compressor**

 **Oil-free compressors are ALWAYS RECOMMENDED.** When using an oil-lubricated compressor, install an oil-removal filter (coalescing type – GRS® #004-730-6MM or equivalent) in the air supply line to this engraving system. Damage due to oil or water contamination IS NOT COVERED BY WARRANTY. Even slight amounts of oil can damage internal parts and cause erratic handpiece operation. The supplied final filter is not capable of removing large amounts of water, oil, or contaminants. See *Setup & Connections* for mounting the supplied air filter to engraving system.

 **If compressed air supply has excessive water, oil, or contaminants, an additional filter/water trap and oil-removal filter (coalescing type) must be installed ahead of the engraving system.**

- The GraverMax® requires a compressed air supply with minimum pressure 45 psi (3 bar) and maximum pressure 120 psi (8 bar). The compressed air supply must have a minimum flow capacity of 1.4 CFM [ft<sup>3</sup>/min] or 40 LPM [L/min]. To ensure a stable compressed air supply, the user should consider an additional air regulator to adjust the air pressure to 45-60 psi (3-4 bar) before it enters the GraverMax®.
- 

- **A sturdy surface with adequate lighting**

Make use of a heavy workbench or suitable solid furniture to support this equipment, workpiece, and any additional equipment and supplies. Adequate lighting allows clear sight, and may help prevent accidents and reduce fatigue.

Placement of this engraving system on the bench is solely user preference and may be determined by left or right hand use during operation.

---

- **Workholding device or material**

For best results, using a workholding device or material is highly recommended. Properly secure the workpiece to ensure user safety and to guard the piece from damage while working. GRS® manufactures several sizes and types of workholding devices, such as the MagnaBlock™, Positioning Vise, MicroBlock® vise, Thermo-Loc® material, and the BenchMate®.

---

## **DO NOT OPERATE ENGRAVING SYSTEM WITHOUT AN ACTIVE AIR SUPPLY CONNECTED.**

The air supply lubricates the rotary valve as the air passes through the system. No additional lubrication is required.

# GraverMax® Overview

## Front View



## Back View

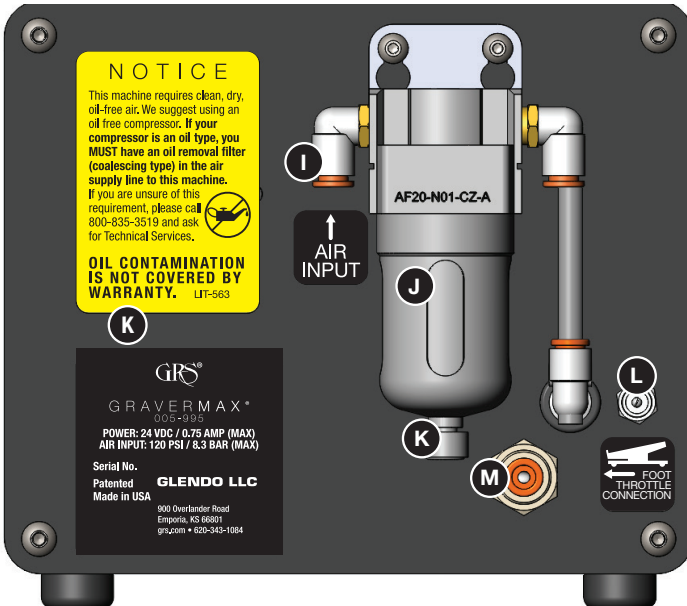

# GRAVERMAX® Overview

- A. Air pressure gauge
- B. Power on/off button
- C. Speed dial
- D. Air pressure control knob
- E. Auxiliary air on/off knob
- F. Handpiece selector knob
- G. Standard Handpiece push-to-connect fittings
- H. Auxiliary tool push-to-connect fitting
- I. Air supply input push-to-connect fitting
- J. Air filter
- K. Air filter bowl drain knob
- L. 24-volt power receptacle
- M. Foot Pedal push-to-connect fitting



## INTRODUCTION

---

The GraverMax® is an engraving system engineered and manufactured under the GRS Tools line of products by Glendo LLC in the United States of America. This system is designed for assistance in creating unique works in metal, stone, wood, ivory, and many other materials.



## OPERATION NOTE

---

### IMPORTANT



**NEVER OPERATE WHILE ON SIDE.** *Always use the system in a vertical position.*

# SETUP & CONNECTIONS

## Hose Connections

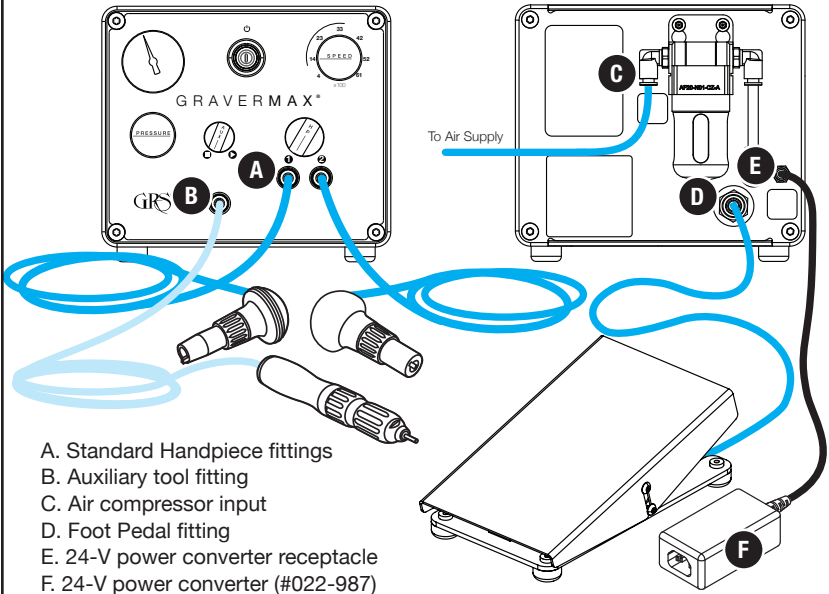

## Connect To Air Filter

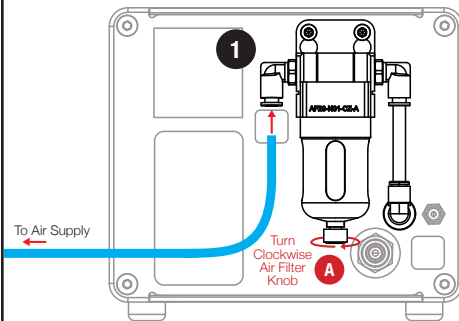

Power off engraving system and air supply. Insert hose from air supply to filter fitting marked "Air Input" (see 1) until the hose stops and is secure.

**A** Drain water from filter daily. Turn knob clockwise (from top view) to open. Drain. Turn knob counter-clockwise to close valve.

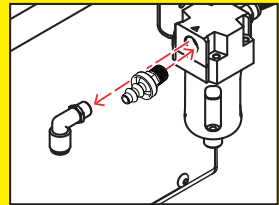

**NOTE:** If air supply hose is larger than 1/4" (6.35 mm) OD, either replace the push-to-connect fitting with the included barbed fitting and attach the air supply hose or purchase a reducer to decrease the OD to 1/4" (6.35 mm).



# SETUP & CONNECTIONS *(CONTINUED)*

## Connect Electrical Power



**DO NOT OPERATE  
ENGRAVING SYSTEM  
WITHOUT AN ACTIVE AIR  
SUPPLY CONNECTED.**

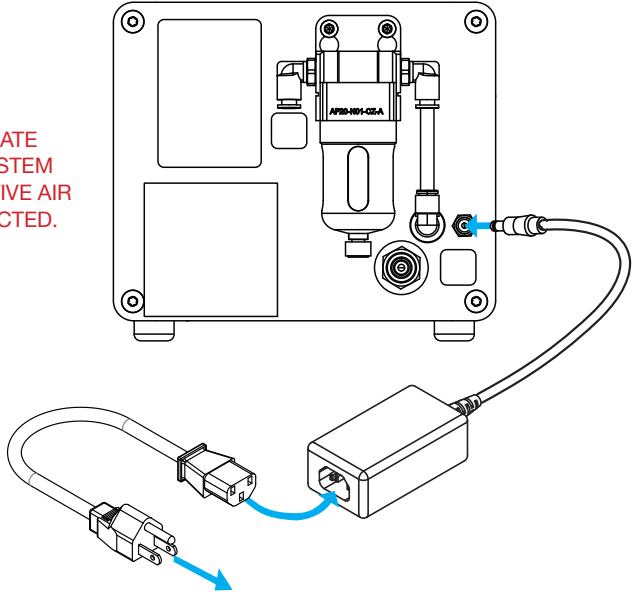

## FIG. 5 • Connect Standard Handpiece(s)

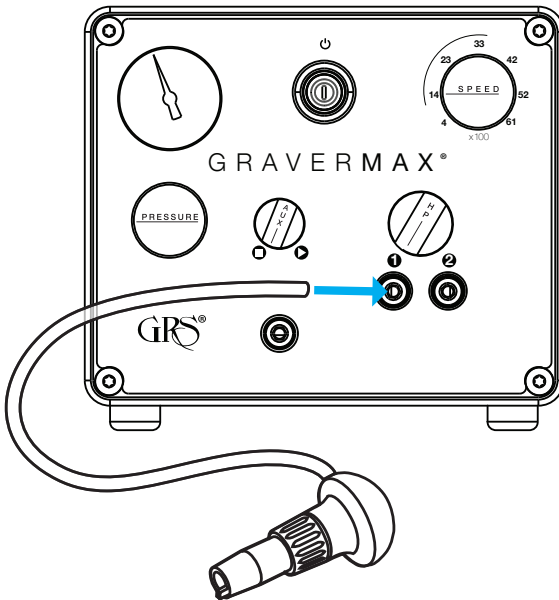

# SETUP & CONNECTIONS (CONTINUED)

## Connect Auxillary Air Tool

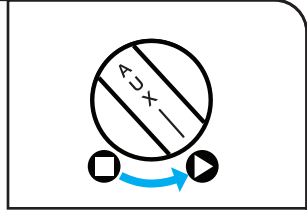
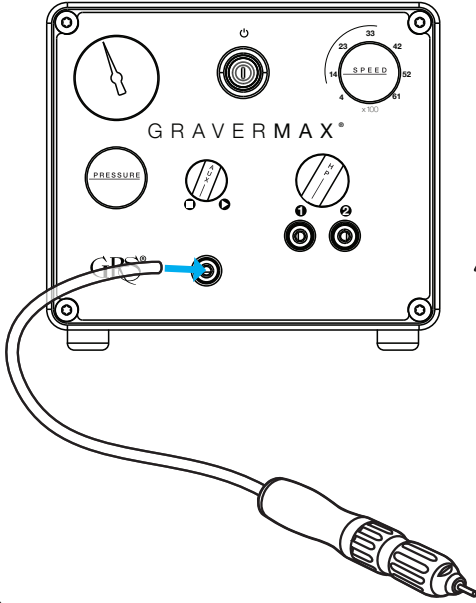

**DO NOT EXCEED 40 psi (2.7 bar) when using auxillary air tools with the GraverMax®. DO NOT EXCEED the Air tool's manufacturer recommended maximum psi.**

## SETUP & CONNECTIONS (CONTINUED)

### Connect Foot Pedal

 **Keep hands away from foot pedal during use to avoid pinching hazard.**

During use, foot should be completely on the foot pedal.



Power on air supply and GRS® Air System to check for leaks and improper connections; air should not escape through any hose or fitting. If air leaks, power off system and air supply. Locate leaks and correct any improper connections. To disconnect from a push-to-connect fitting, press in on the front of the fitting while gently pulling out the hose.

**NOTE:** The foot pedal varies handpiece power by controlling the amount of air that flows from the handpiece. While the pedal is depressed, it is normal for air to be released. The user may hear the air being released at times during operation.

**SPECIAL NOTE:** When powered on, the system pushes a small amount of air through the electrically-controlled air solenoid valve. When powered off, the system seals the valve, making a “pop” and “hiss” sound. This allows the system to be powered off while the air compressor remains on—without loss of air in the compressor tank.

# POWER & SETTINGS

Power on the air compressor and allow tank to fill.

Wait for the compressor to cycle off.

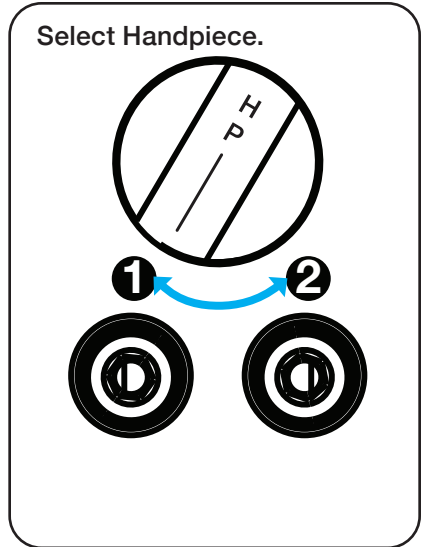
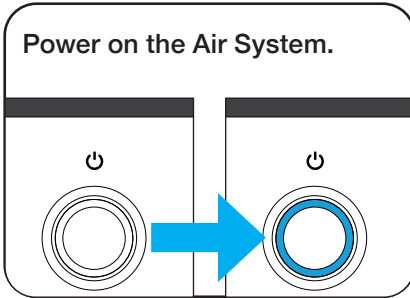

# HANDPIECE TUNING

Turn the Speed Dial to 2300.

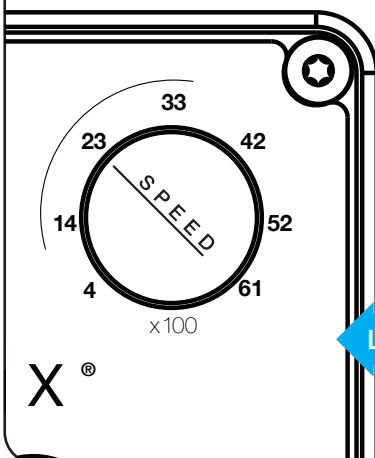

## SPEED

Stroke speed is a matter of personal preference and experience. Experiment with the settings to better understand how the speed relates to technique.

Each handpiece has a normal speed range. Operating outside this range can produce erratic results.

Strokes Per Minute

LOW

HIGH

STIPPLING AND SIMILAR TECHNIQUES

MAXIMUM-POWER TASKS

FINE CUTS AND FINISHES

# HANDPIECE TUNING (CONTINUED)

Set the Air Pressure to 5 psi (0.4 bar).

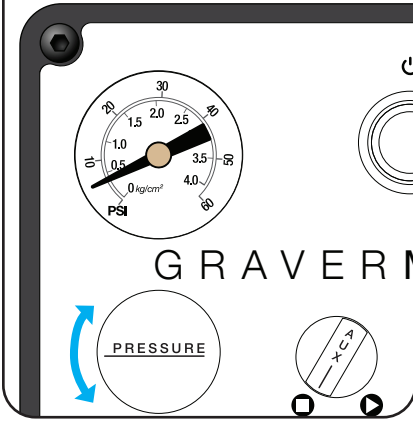

Hold the selected handpiece vertically near either ear as shown.

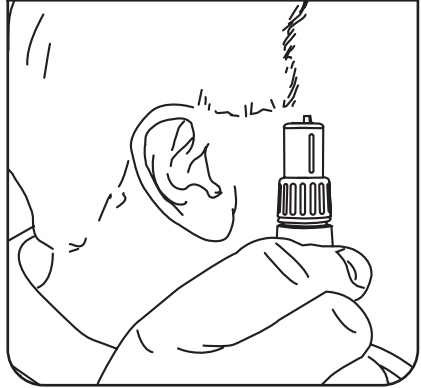

**WITHOUT** operating the pedal, slowly increase the air pressure.

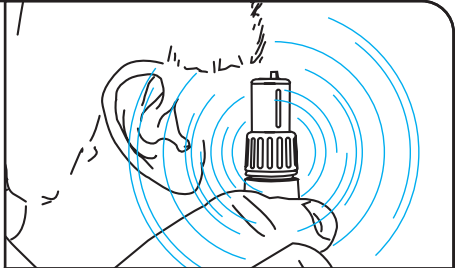
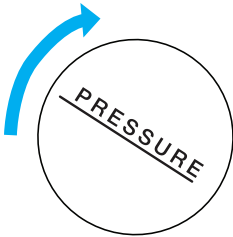

Once the pressure increases enough, the handpiece will begin to knock.

Stop adding air pressure immediately after the knocking stops.

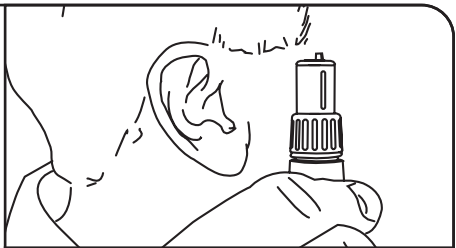
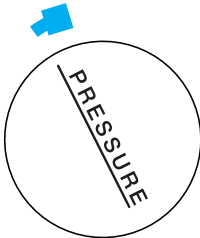

This is the perfect air pressure operating range for the selected handpiece model.

# HANDPIECE TUNING *(CONTINUED)*

The settings in the chart may be used for adjusting the selected handpiece; this method is not as precise. Set the SPM dial and the air pressure control knob to the Recommended Initial Setting for the selected handpiece.

## HANDPIECE FINE ADJUSTMENT

| HANDPIECE  | TYPE     | SPEED<br><i>Operating Range</i><br>Recommended | PRESSURE<br><i>Operating Range</i><br>Recommended  |
|--|----------|--|--|
| <b>Magnum®</b><br>004-940, 005-940-AT              |          | 800-3400<br><b>2400</b>                        | 18-22 psi (1.2-1.5 bar)<br><b>20 psi (1.4 bar)</b> |
| <b>901®</b><br>004-901, 004-910,<br>005-901-AT     | Standard | 1400-4000<br><b>2400</b>                       | 17-22 psi (1.2-1.5 bar)<br><b>19 psi (1.3 bar)</b> |
|  | Fine     | 1400-4000<br><b>2400</b>                       | 12-15 psi (0.8-1.0 bar)<br><b>13 psi (0.9 bar)</b> |
| <b>Monarch™</b><br>004-921, 004-926,<br>005-921-AT | Standard | 2000-5000<br><b>3000</b>                       | 10-13 psi (0.7-0.9 bar)<br><b>11 psi (0.8 bar)</b> |
|  | Fine     | 2000-5000<br><b>3000</b>                       | 6-8 psi (0.4-0.6 bar)<br><b>7 psi (0.5 bar)</b>    |
| <b>Maestro™ MX</b><br>004-909                      |          | 600-3200<br><b>2200</b>                        | 18-22 psi (1.2-1.5 bar)<br><b>20 psi (1.4 bar)</b> |
| <b>Maestro™ EX</b><br>004-905                      |          | 800-3600<br><b>2200</b>                        | 17-22 psi (1.2-1.5 bar)<br><b>19 psi (1.3 bar)</b> |
| <b>Maestro™</b><br>004-947                         |          | 2000-5000<br><b>3000</b>                       | 10-13 psi (0.7-0.9 bar)<br><b>11 psi (0.8 bar)</b> |
| <b>QC 720</b><br>004-720                           |          | 400-3000<br><b>1600</b>                        | 18-26 psi (1.2-1.8 bar)<br><b>22 psi (1.5 bar)</b> |
| <b>QC 710</b><br>004-710                           |          | 800-3000<br><b>1800</b>                        | 20-24 psi (1.4-1.7 bar)<br><b>21 psi (1.4 bar)</b> |
| <b>610 Hammer</b><br>004-610                       |          | 800-3000<br><b>1800</b>                        | 20-24 psi (1.4-1.7 bar)<br><b>21 psi (1.4 bar)</b> |

# OPERATION & TROUBLESHOOTING

Depress the foot pedal to actuate the standard handpiece.

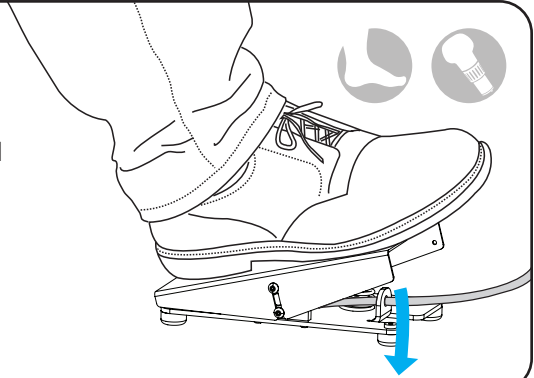

Apply more pressure to foot pedal to increase handpiece power.

Rely on increasing the power provided by the handpiece instead of manually pushing through the cut. Manual pushing is an incorrect use of the handpiece and can result in the tool slipping.

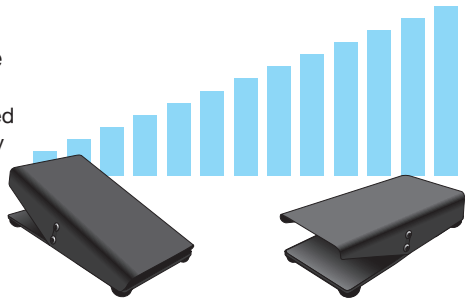

Handpiece will be difficult to control if the air pressure or speed is incorrect. Use the lowest air pressure setting to provide proper operation; do not set the air pressure higher than needed.

## HANDPIECE ADJUSTMENT TROUBLESHOOTING

- Handpiece vibrates or knocks without using the Foot Pedal: air pressure is too low; tune handpiece (See previous section).
- Handpiece power decreases at full pedal: air pressure is too low or the speed is too high; reset pressure or speed.
- Handpiece does not operate within 3/8" (9.525 mm) of depressing foot pedal: air pressure is too high; decrease to proper air pressure.

Make fine adjustments in air pressure or speed until proper operation is attained. The handpiece will operate smoothly and predictably once adjusted properly. Before cutting, position handpiece and tool properly. The tool should rest firmly on the material surface before operating the system.

# IMPORTANT NOTICES

---

## AIR CONTAMINANTS AND WATER ACCUMULATION

If large amounts of water and contaminants are in the air supply to the system, the bowl must be drained frequently to prevent water from entering the rotary valve, hoses, handpiece, etc. Check all filters, bowls, hoses, etc., twice a week to prevent accumulation. Additionally, the filter element must be cleaned and/or replaced frequently. If moisture is noted in the handpiece or throttle hoses, power off system immediately. Purge air from system, drain filter bowl, and proceed as follows:

- Disassemble and clean handpiece(s). Reassemble.
  - Set primary air pressure to 10 psi (0.7 bar). Power on the system to purge moisture from valves, hoses, etc.
  - Before powering on engraving system, locate source of moisture and correct problem. An additional filter or water trap in the air line may be necessary.
- 

## SERVICE & REPAIR

---

Prior to performing any maintenance or repair, turn off the power and disconnect the power converter. Disconnect the air supply, then depress the foot control to bleed off any remaining air pressure.

Please call GRS® or an authorized GRS® dealer to order replacement parts and for instructions on replacement. Do not attempt to service parts that must be sent to GRS® or an authorized GRS® dealer; these must be repaired or replaced by GRS® or an authorized GRS® dealer. Servicing parts not signified as operator serviceable will void the 2-year warranty. **Any part not noted as replaceable or serviceable by the operator must be sent in to GRS® or an authorized GRS® dealer for repair.**



See LIT-580 for a full list of parts and operator serviceable parts.



# GRAVERMAX® SPECIFICATIONS

---

## DIMENSIONS

**SIZE:** 7.12" x 9.3" x 6.3" [181 mm x 236 mm x 160 mm]

**WEIGHT:** 10.3 lb [4.672001 kg]

---

## ENVIRONMENTAL OPERATING CONDITIONS

**Temperature range:** 40°F [4°C] to 100°F [38°C]

**Relative humidity:** Up to 85% at a maximum temperature of 100°F [38°C]

**Altitude:** Up to 10,000 ft [3048 m] above mean sea level

**Transportation and storage temperature range:** 0°F [-18°C] to 120°F [49°C]

---

## ELECTRICAL SUPPLY REQUIREMENTS

**Voltage:** 100/220 VAC

**Frequency:** 50/60 Hz

**Phases:** 1

**Current:** 1.2 A

---

## PNEUMATIC SUPPLY REQUIREMENTS

**Max Input Pressure:** 120 psi [8 bar]

**Recommended Input Pressure:** 45-60 psi [3-4 bar]

**Flow Rate:** 1.4 CFM [40 LPM]

---

## ISO STANDARDS

Pneumatic systems and their components are in accordance ISO 4414.

---

## SOUND EMISSIONS

**Max Sound Level:** 70.9 dBA / 76.8 dBC\*

*\*Measured at 39.4" (1 meter) from the equipment*

---

# NOTES

---

---

---

---

---

---

---

---

---

---

---

---

---

---

---

---

---

---

---

---

---

---

---

---

---

---

---

---

---

---



# WARRANTY

---

Each GRS Air System, including provided foot pedal, carries a full 2-year warranty covering parts and labor. Contact GRS® or an authorized GRS® dealer before returning any equipment.



These products are designed for reliable operation using most sources of compressed air. However, some air supplies contain excessive water, oil, dirt, rust, or other contaminants. The built-in filter of the engraving system is a final filter to protect against normal dirt and water. If the compressed air has excessive contaminants, install the necessary filter(s) and water trap(s) ahead of the engraving system.



Oil contamination can be gradual and subtle. If an oil residue (usually yellow or brown, sticky or liquid) becomes present in the filter bowl of the engraving system, or in the handpiece / pedal hose, the compressed air most likely contains oil or contaminants. Older oil lubricated and “silent” compressors that use internal oil are more likely to cause oil contamination. If this occurs, install a Coalescing Oil Filter (GRS® #004-730-6MM or equivalent).

**NOTE: Damage caused by contaminated compressed air is not covered by the warranty.**



**Glendo LLC**

900 Overlander Road  
Emporia, KS 66801 USA

**Phone:** +1-620-343-1084

**Fax:** +1-620-343-9640

**E-mail:** [glendo@glendo.com](mailto:glendo@glendo.com)

**grs.com**

---

GRS®, GraverMach® AT, GraverMach®, GraverMax® G8, GraverMax®, GraverMate®, GraverSmith®, BenchMate®, GraverMeister®, MicroBlock®, Airtact®, BenchMate Encore®, Acrobat®, Thermo-Loc®, GRS Apex®, MicroBlock®, Satellite®, 901®, C-Max®, GlenSteel®, Magnum®, GraverHone® VS, and Optia® are trademarks of Glendo LLC. Covered by USA and foreign patents. Printed in USA. Products made in USA.  
© 2009–2024 Glendo LLC. All rights reserved.

---

**LIT-566-GraverMax\_Domestic**

Last Update: 14/08/2024